

2022

BEGA

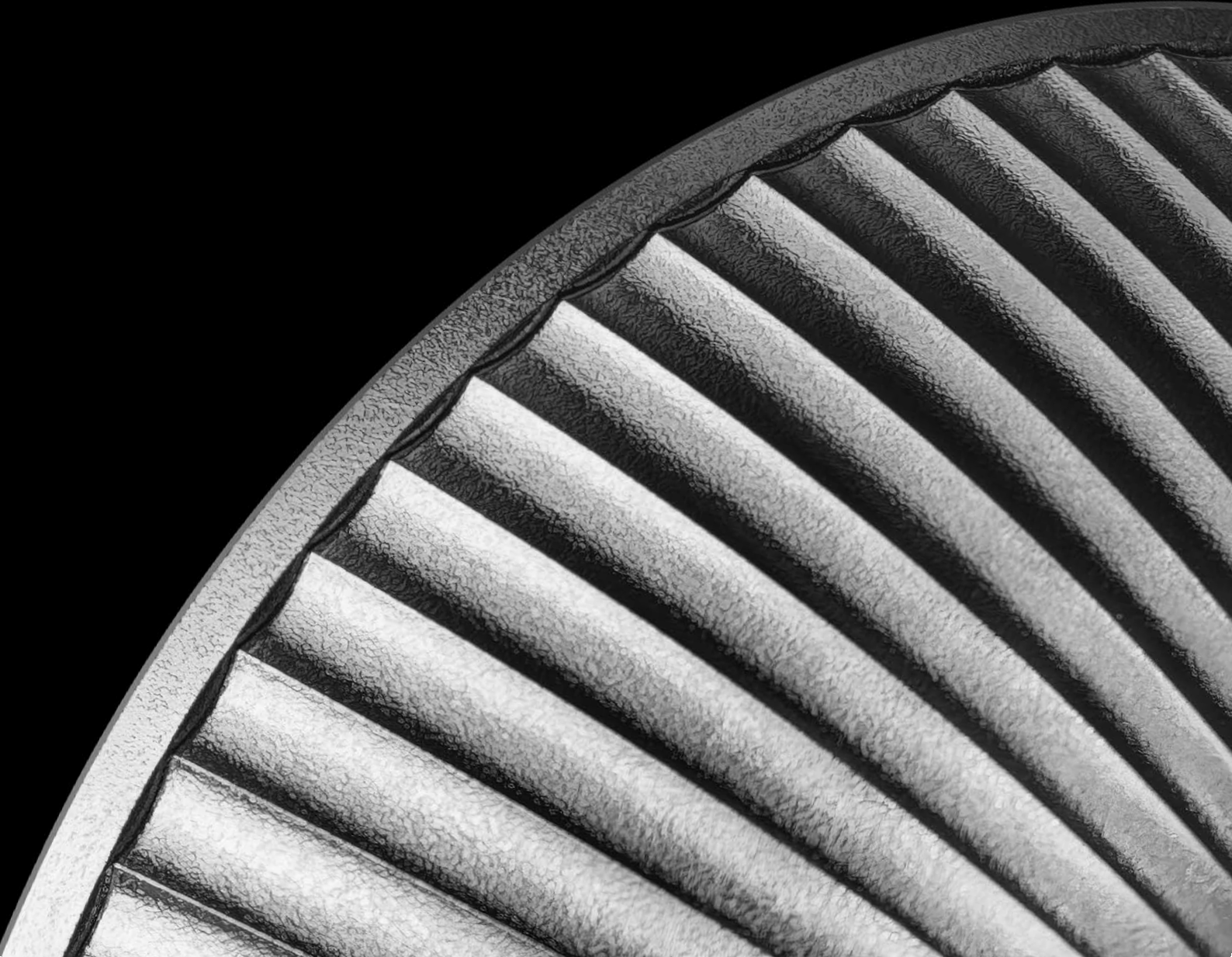

Das gute Licht.

Innovations – made by BEGA

Our 2022 innovations are groundbreaking and have been developed for the demanding requirements and wishes of our customers.

The BEGA range enables lighting design of the highest quality from a single source. The products are optimally coordinated, sustainable and feature an unprecedented range of luminaires.

We are pleased to provide you with a compact overview of our 2022 innovations in this brochure.

Discover new forms, efficient lighting technology and an even greater variety of products for your lighting projects!

All products can now also be found on our website – please note the product webcodes provided for quick access to further information.

New downlights with Zoom optics

Half beam angles in our recessed and surface-mounted ceiling luminaires can be individually adjusted thanks to our new BEGA Zoom optics.

The desired half beam angle can be set anywhere between 15° and 50° by turning the lens and reflector unit – even when the luminaire is installed and connected.

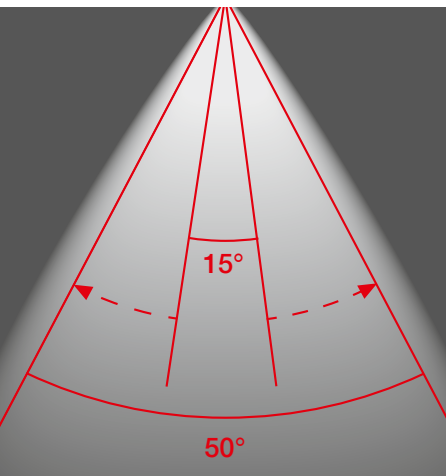



Minimal diffuse light percentage for glare-free light accents

We have developed a new optical system especially for situations that demand technical luminaires with as low a diffuse light percentage as possible.

We use this symmetrically focused light distribution in our recessed ceiling luminaires and surface-mounted ceiling luminaires as well as in two of our recessed in-ground luminaire systems – for maximum visual comfort guaranteed.

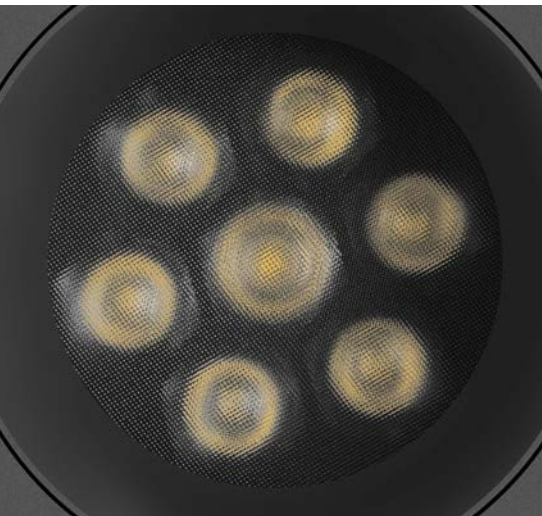



The new gobo floodlight, **technically compact and efficient**

Our new BEGA gobo floodlights for the projection of logos, texts and images boast a compelling design and economic efficiency.

A highly efficient illumination tool for precise graphic lighting effects.

Q P 0383

Size

Ø 145 · 175 mm

Adjustable beam angle

10°–30°

Mounting

Mounting box or

G ½" connecting thread

RGBW

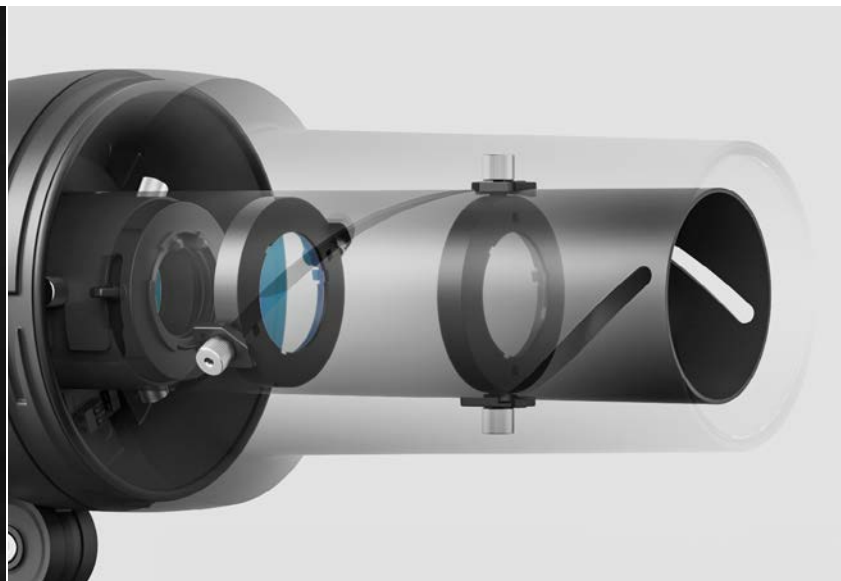





Compact floodlights reloaded – **better than ever**

With five different sizes, a luminaire luminous flux of up to 9200 lumens and a renowned range of accessories, the BEGA compact floodlight is a specialist for all types of illumination.

Highly efficient optical systems with minimal stray light and the availability of BEGA Zoom optics make it the perfect lighting tool.

Size

Ø 100 · 120 · 150 · 180 · 255 mm

Luminaire luminous flux

560 – 9200 lm

Q P0380



Hightech under water

This new BEGA underwater floodlight sets new benchmarks in terms of materials and lighting technology.

Intensive research and numerous tests have resulted in the use of a new lead-free, seawater-resistant cast brass alloy with drinking water approval.

BEGA Hybrid Optics® achieve a luminous flux of more than 5000 lumens with a half beam angle of either 24° or 64°.

Size

Ø 230 mm

Luminaire luminous flux

2400 – 5100 lm

RGBW





Q P 0387



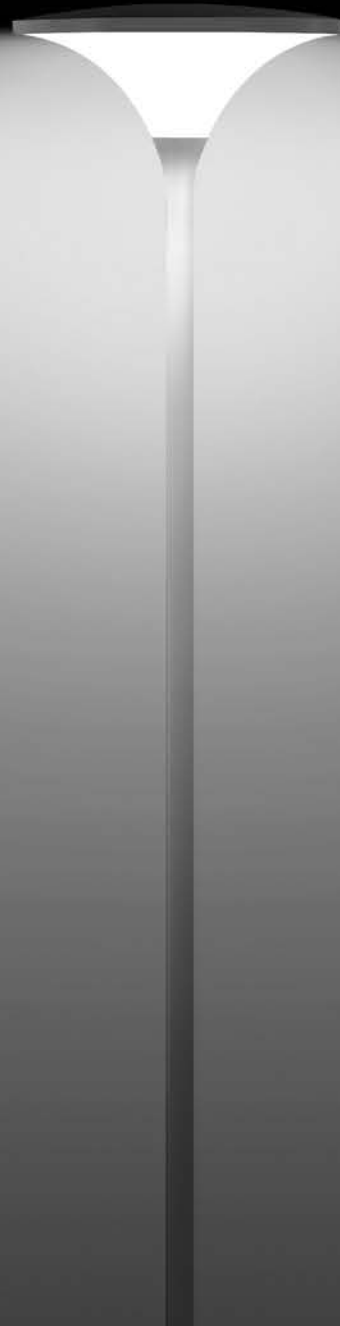

BEGA UniLink®

Individually and **universally usable**

The shielded light of this new portable garden luminaire creates atmospheric points of light in private gardens – completely flexible thanks to BEGA UniLink®.

Size

Ø 200 mm

H 520 · 1020 mm

Luminaire luminous flux

570 lm

🔍 P 0347



Q P 0420 · P 0397



The Collection BOOM

Entirely new facets:

Colour bronze

Many of our garden luminaires are available in a new colour: bronze. The lacquer finish in a highly weather-resistant layered structure has the look and feel of cast bronze.



Q P 0363



Q P 0349



Q P0398



Q P0423



Q P0458



Q P0399





Protecting the **night hawks**

This new pole-top luminaire is the answer to many of today's lighting design requirements.

With a luminous flux of less than 1% in the upper half-space, it helps to maintain the darkness of the night sky.

Featuring two light distributions, it is ideal for most planning tasks in public spaces. It is optionally available with a Zhaga interface.

Size

Ø 550 mm

Luminaire luminous flux

2400 · 3000 lm

🔍 P 0385

3000 K



1800 K

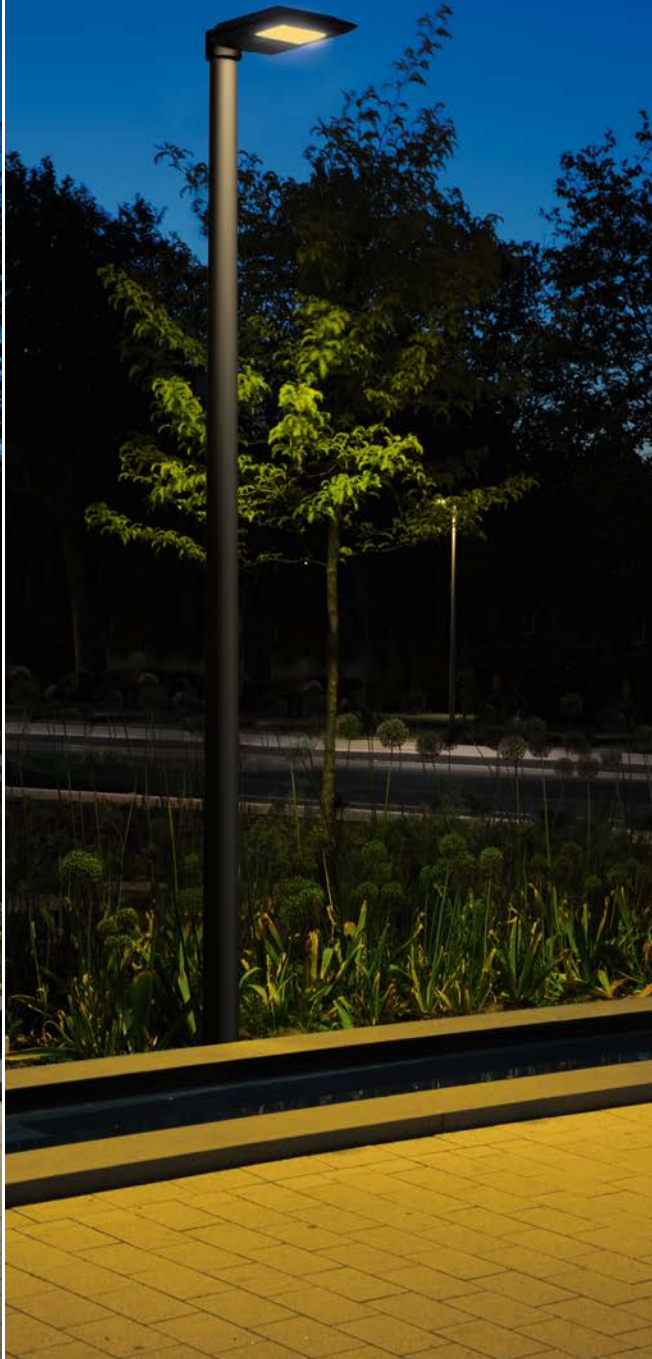



Insect-friendly illumination: **our BugSaver technology**

The regular LED colour temperature of 3000 Kelvin in BEGA BugSaver pole-top luminaires can be switched to blue light-reduced light of 1800 Kelvin with the aid of the associated control devices.

This light, produced by phosphor-converted amber, helps to protect the habitat of nocturnal insects.



BugSaver control devices
for switching colour
temperature and power
reduction



Q P 0421



Q P 0369





The Collection BOOM

A classic in a new guise

These wall luminaires in basic round and square designs are a modern interpretation of the traditional lantern: in a clear design language and with the latest LED technology. Contemporary and innovative, they bridge the gap to their historical models.

Size

□ 145 mm · Ø 165 mm

Luminaire luminous flux

950 · 1150 lm

🔍 P 0351



The Collection BOOM

Iconic shape with playful lighting technology

Combining creative lighting technology with a traditional silhouette, these wall luminaires are suitable for use in both historic and contemporary architecture.

We also offer the wall luminaires in basic round and square designs in a bronze colour.

Size

□ 145 mm · Ø 165 mm

Luminaire luminous flux

950 · 1150 lm

🔍 P 0323







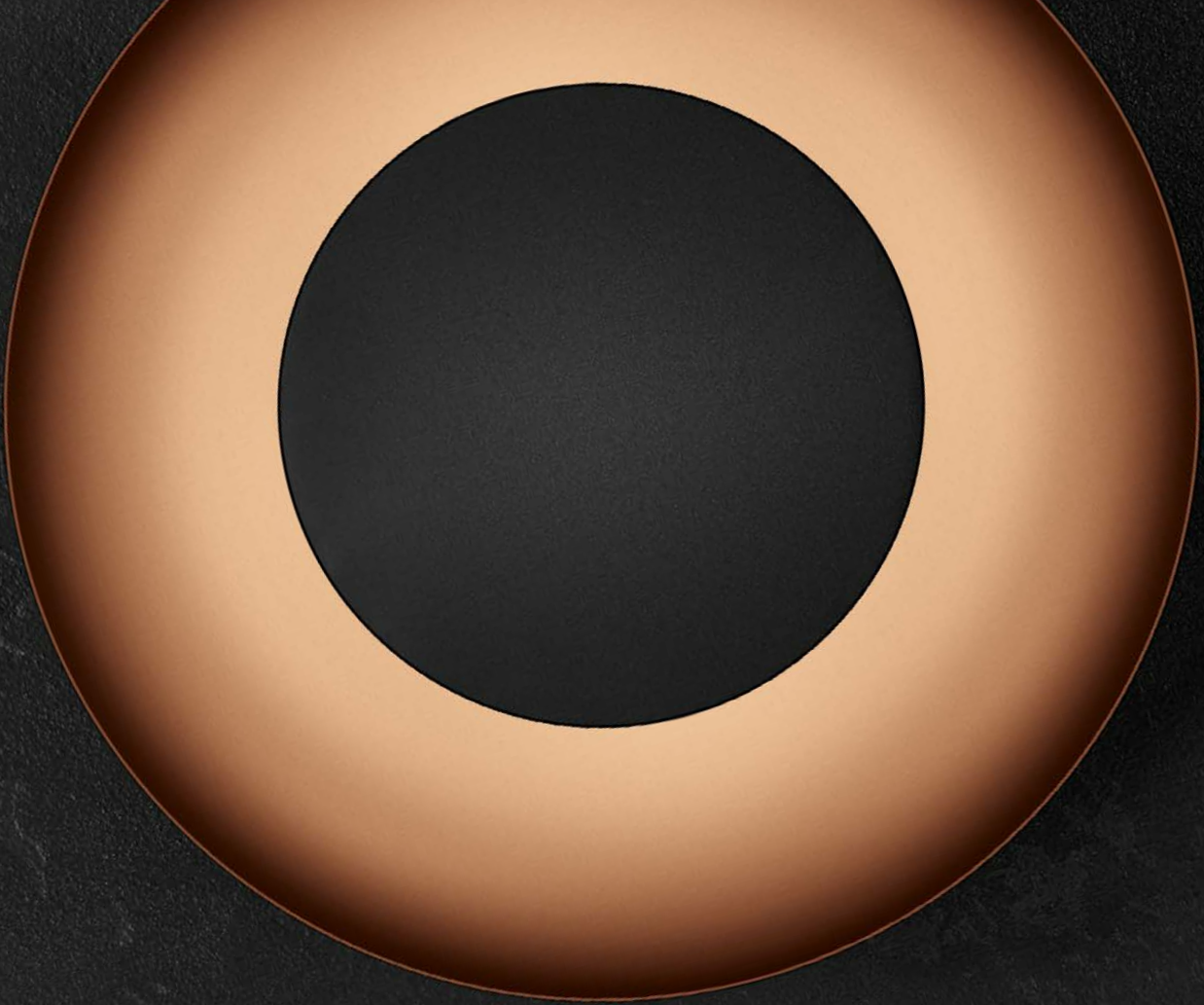

Get inspired by our new
**lighting solutions for
interiors.**



New downlights with **Zoom optics**

Half beam angles in our recessed and surface-mounted ceiling luminaires can be individually adjusted thanks to our new BEGA Zoom optics.

The desired half beam angle can be set anywhere between 15° and 55° by turning the lens and reflector unit.



Size

Ø 140 · 155 mm

Luminaire luminous flux

840–1550 lm

Q P 0173



Size

Ø 90 · 120 · 135 mm

Luminaire luminous flux

370–2000 lm

Q P 0211

Q P 0261

Q P 0136



Perfect package **for full flexibility**

BEGA track spotlights represent a powerful range of luminaires for integration into 3-phase Eurostandard® Plus track systems.

Choose the right spotlight for your requirements from a wide and versatile range of light outputs and light distributions – with 3000 or 4000 Kelvin; Tunable White or RGBW; with light outputs of up to 3800 lumens.

Q P0263

Q P0201



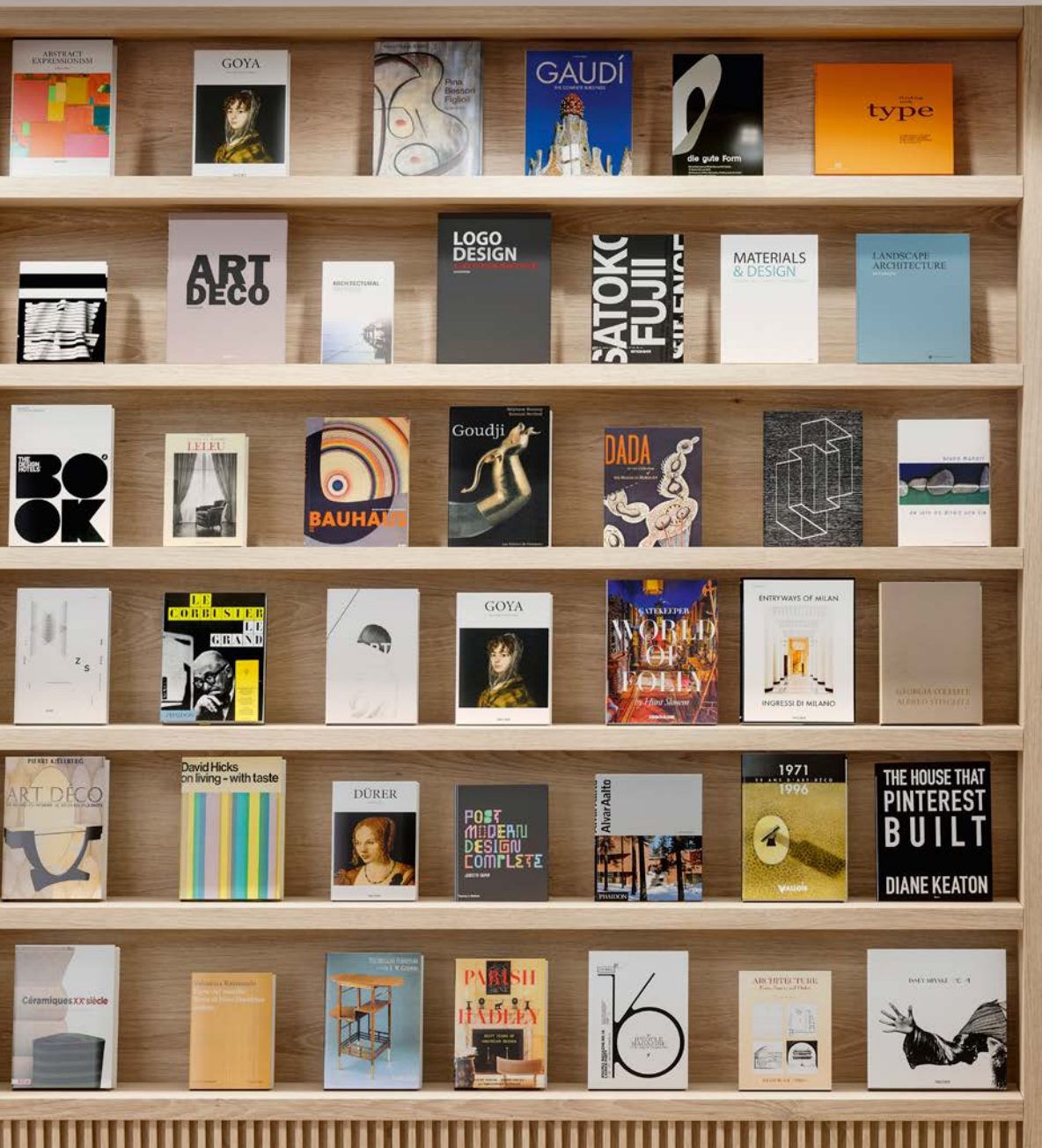

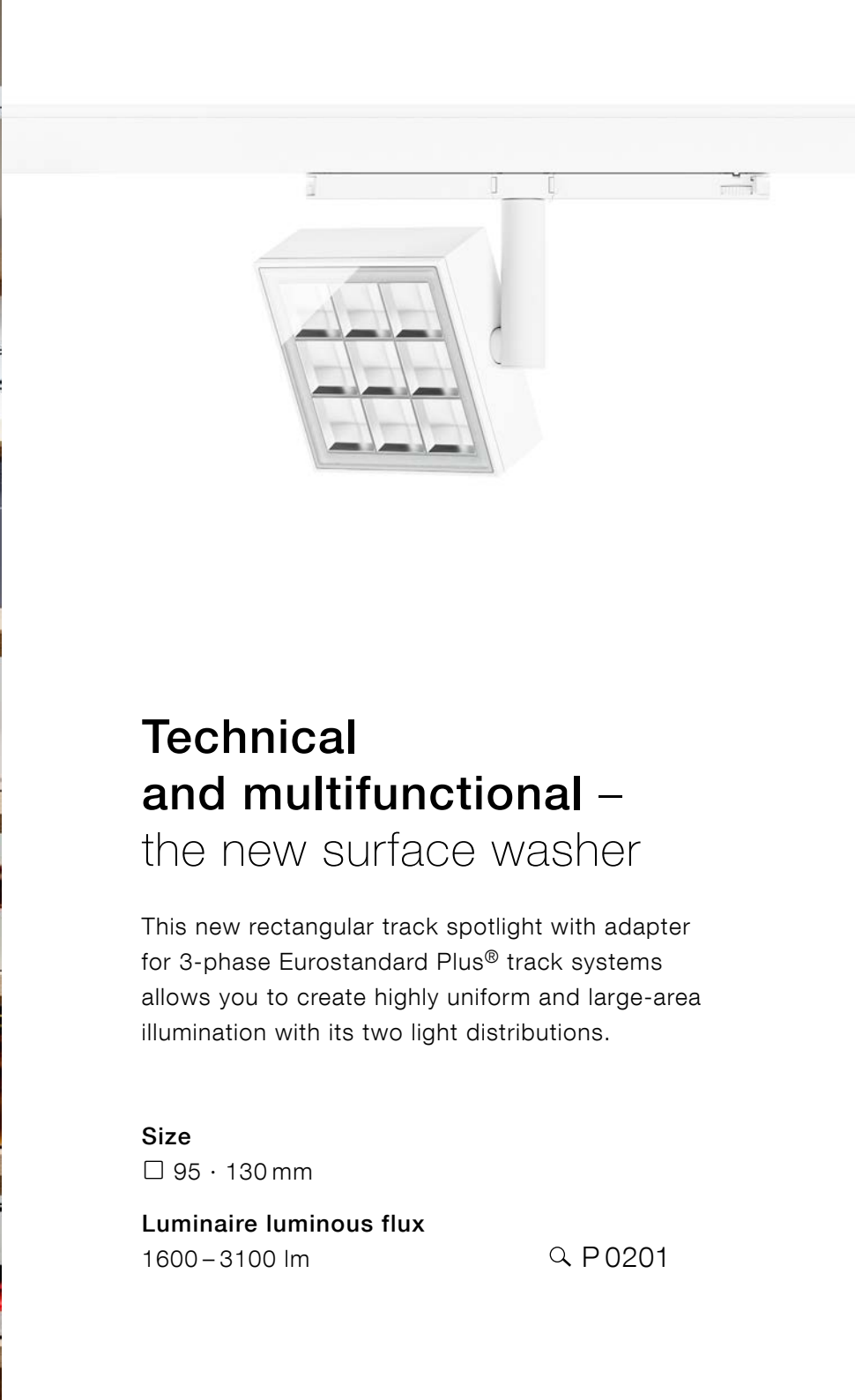

Technical and multifunctional – the new surface washer

This new rectangular track spotlight with adapter for 3-phase Eurostandard Plus® track systems allows you to create highly uniform and large-area illumination with its two light distributions.

Size

□ 95 · 130 mm

Luminaire luminous flux

1600 – 3100 lm

Q P0201





Inspired by **nature**

Inspired by pebbles by the sea, these luminaire glasses fascinate the observer by lighting up the room in a playful way.

Available in two different shapes and two different sizes, you can create countless arrangements almost as random as pebbles by the sea – and they are all the more beautiful when illuminated.

Size

355 – 525 mm

Luminaire luminous flux

950 · 2400 lm

Q P 0251



Precise form

with protection class IP 44

Linear light with very fine lines in three lengths. Suitable for lighting in bathroom areas in accordance with VDE 0100, these luminaires ensure a high level of visual comfort whether installed vertically or horizontally – and not only in the bathroom.

Length

600 · 800 · 1000 mm

Luminaire luminous flux

2600 – 4400 lm

Q P0101





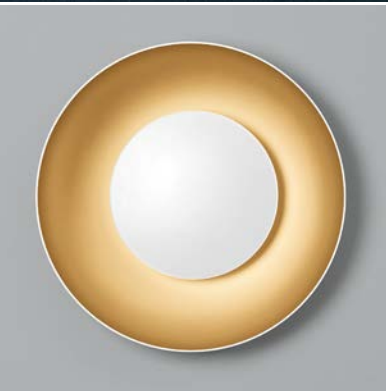
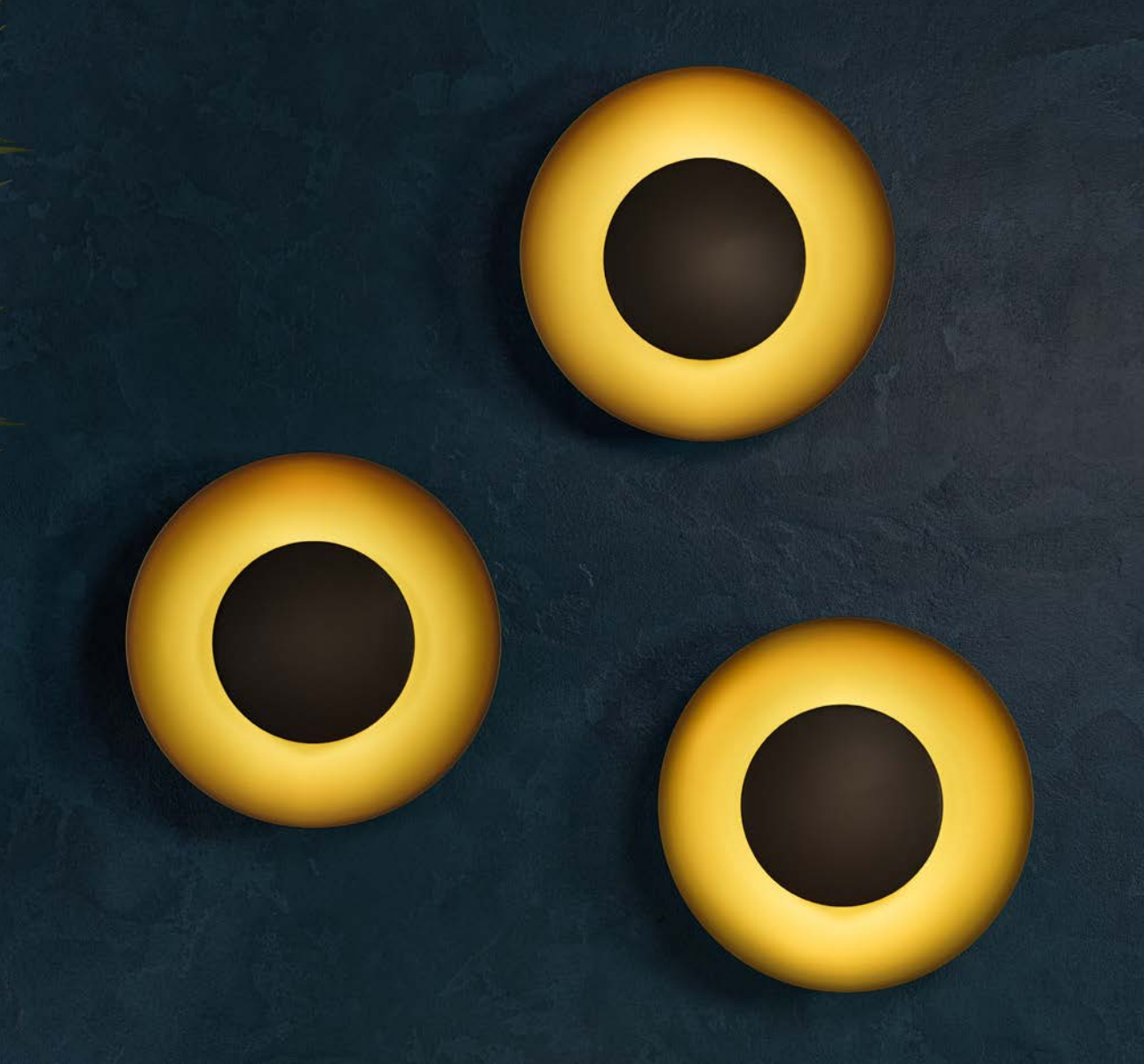

STUDIO LINE

Endless

design possibilities

Luminaires that take on impressive design tasks far beyond their pure lighting function. They are simultaneously luminaire and light object and boast a compelling light effect as well as high-quality materials.

Size

Ø 500 · 700 mm

Luminaire luminous flux

260 – 400 lm

Q P0159







STUDIO LINE

Illuminated mirrors – more than just a luminaire

Luminaire, light object and mirror – a fascinating combination in a single object.

Arranged in groups, they capture the surroundings when unlit and inspire with the variety and randomness of the reflected images.

Size

Ø 500 · 700 mm

Luminaire luminous flux

1170–2870 lm

Q P 0191

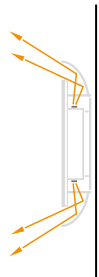





STUDIO LINE

Light that
creates atmosphere

Classic luminaires in a new guise, yet reminiscent of traditional forms. The upward and downward light emission and unconventional wall mounting bracket set unusual accents.

Length

435 mm

Luminaire luminous flux

1020 · 1100 lm

Q P 0233

Linear light

upwards and downwards

Two pendant luminaires in non-standard lengths, available in two versions: straight with rectangular cross section or with concave sides.

In both versions, the light is distributed softly and uniformly by a silicone diffuser embedded in the luminaire profile.

Length

770 · 1170 · 1870 mm

Luminaire luminous flux

1340 – 6425 lm





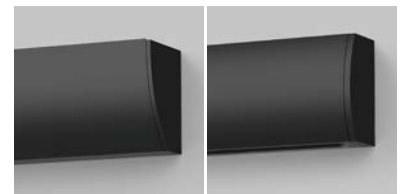

Q P0110

Q P0151



Linear light for the wall

Two wall luminaires that emit their light by means of an embedded light-diffusing silicone diffuser – in either one or two directions onto the installation surface depending on the type. The front-shielded luminaires have a low projection and create a unique aesthetic on the wall whether installed individually or in groups.

Length

740 · 1140 · 1840 mm

Luminaire luminous flux

960 – 7070 lm

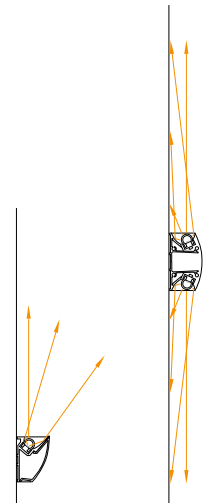





works with
BEGA Smart



STUDIO LINE

Classic design with delicate accents

These luminaires are part of our system pendant luminaire range. The classic form is complemented by new accents through the light emission on both sides.

The versatile installation components of our system pendant luminaires allow maximum flexibility for mounting on ceilings of any kind as well as in track systems.

Length

Ø 215 mm

Luminaire luminous flux

1860 – 1970 lm

Q P 0243



works with
BEGA Smart

STUDIO LINE

System pendant luminaires

The contrast between the exterior colour and the metallic inside colour stands out particularly clearly in these pendant luminaires. The metallic luminaire housing shields the downward directed light. Part of the light emerges upwards, highlighting the luminaire's form and materials.

The versatile installation components of our system pendant luminaires allow maximum flexibility for mounting on ceilings of any kind as well as in track systems.

Size

Ø 190 · 230 mm

Luminaire luminous flux

605 – 1160 lm

Q P0144





works with
BEGA Smart

STUDIO LINE

System pendant luminaires

These new slim pendant luminaires emit very little stray light. The additional upper light emission makes the contrast between the exterior colour and the metallic inside colour tone clearly visible.

The versatile installation components of our system pendant luminaires allow maximum flexibility for mounting on ceilings of any kind as well as in track systems.

Size

Ø 160 · 195 mm

Luminaire luminous flux

550 – 1060 lm

Q P 0176







works with
BEGA Smart

Unshielded system pendant luminaires

The light of these unshielded pendant luminaires creates excellent room illumination. The efficient luminaires emit just as much light upwards onto the ceiling surface as downwards towards the floor.

One version features an integrated low-beam downlight which increases the degree of illuminance on the surfaces below the luminaire.

The versatile installation components of our system pendant luminaires allow maximum flexibility for mounting on ceilings of any kind as well as in track systems.

Size

Ø 250 · 350 mm

Luminaire luminous flux

2400 – 4300 lm



Q P 0266

Unshielded and downward-directed **all-rounders**

These new spherical pendant luminaires add another technical function to the classic decorative form. They include both a unshielded light component for high vertical illuminance and additional downward-directed light for a high degree of illuminance below the luminaires.

An upper light emission extends the possible range of applications.

Size

Ø 450 · 550 · 650 mm

Luminaire luminous flux

7690 – 18520 lm

Q P0145









STUDIO LINE

Floor lamps for **a versatile range of uses**

These new floor lamps create both light and atmosphere with their upward and downward light emission.

The fascinating interplay of the different colour combinations of our STUDIO LINE series luminaires is impressive in any ambience.

Size

Ø 215 mm

Luminaire luminous flux

1295 · 1355 lm

🔍 P 0230

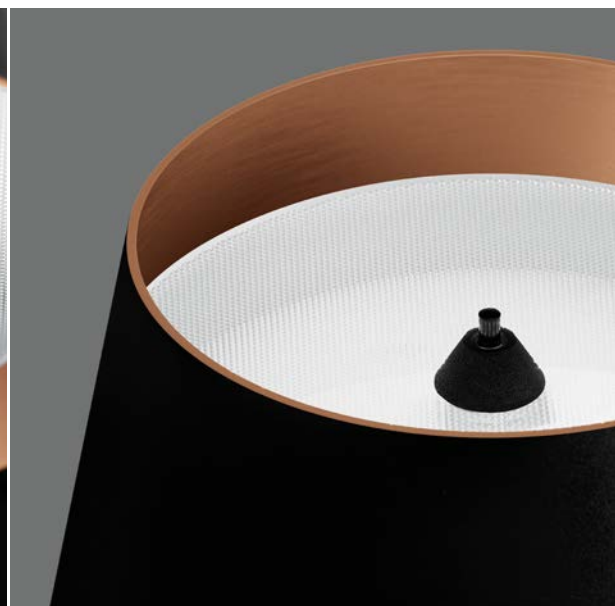

STUDIO LINE

Chandeliers – reinterpreted

Chandeliers make a striking impression on the room during the day with their dimensions alone. They fully reveal their fascinating effect when illuminated.

Our new chandelier pendant luminaires from the STUDIO LINE series boast not only impressive performance, but also versatility and high-quality materials.

Size

Ø 2000 mm

Luminaire luminous flux

17 880 – 19 560 lm

Q P 0225

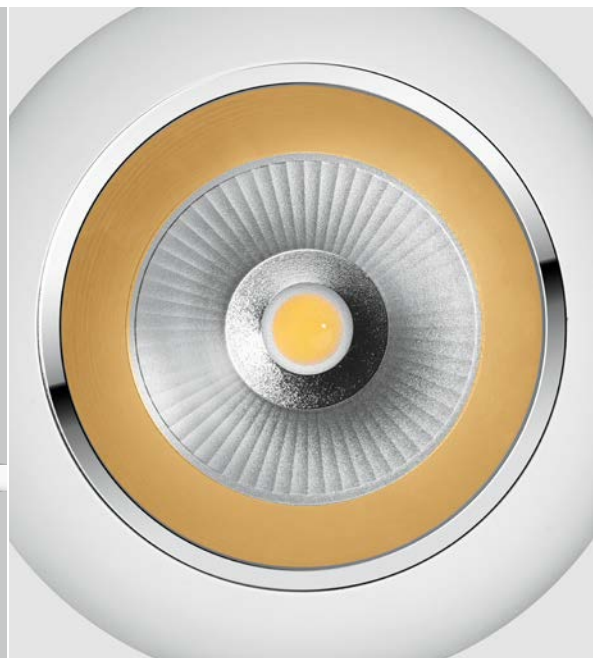





SIMPLE EVERYWHERE. SIMPLE ANYWHERE.

Professional light control is now easier than ever – **anywhere** and **everywhere**. Because BEGA Connect brings your lighting system into the cloud. Extremely practical: the **BEGA Air Connector** provides the Internet connection required thanks to narrowband IoT.

connect.bega.com

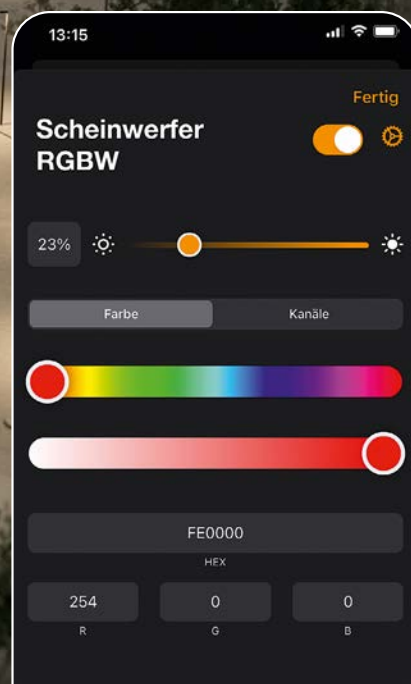

Imprint

Editors: BEGA, Menden
Printed by: LUC, Greven
Lithography: RGI, Dortmund

Concept, design and photography are the joint work
of our company's designers.

BEGA Gantenbrink-Leuchten KG
P.O. Box 3160 · 58689 Menden
Hennenbusch 1 · 58708 Menden
Germany
Phone +49 2373 966-0
www.bega.com · export@bega.com

We reserve the right to make changes in design and technology.
Colours may vary in printing.

© BEGA · 2022

